

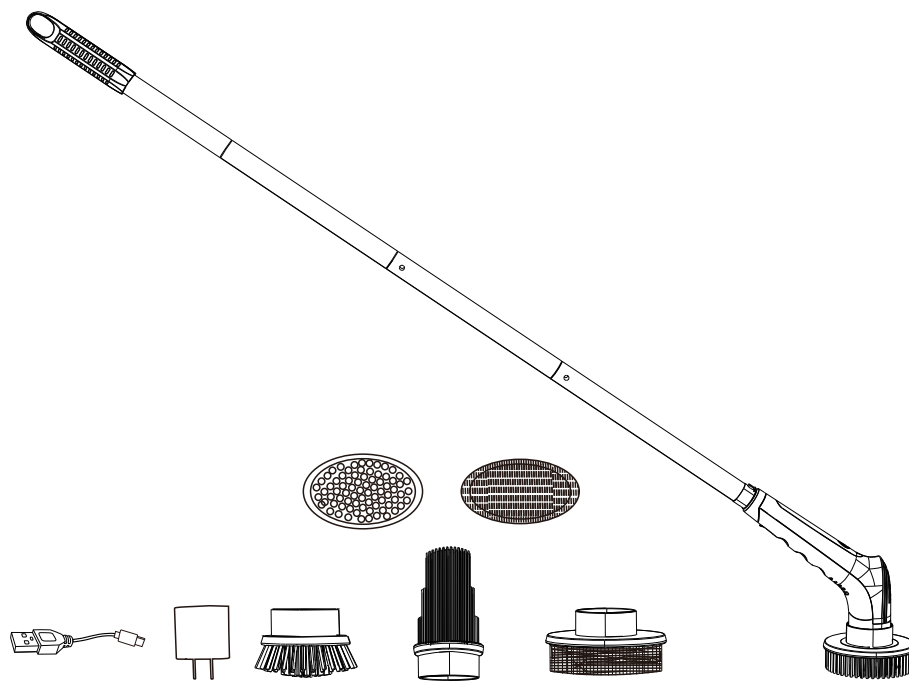

HG086 USER MANUAL

hygger 6 in1 aquarium electric cleaning brush



The noise level of this product is 50- 60dB, which is within the normal range. Thanks a lot for choosing our product! Please read this user manual carefully before use and keep it for future reference.

Safety Instructions



Caution: When using electrical appliances, it is important to follow basic safety precautions, including the following:

1. Avoid operating this product near flammable or explosive substances.
2. Ensure that the brush head is securely installed before use and avoid shaking or swinging the product vigorously.
3. When using this product with irritating substances, please wear eye protection and gloves to prevent splashing onto the body.
4. Do not insert any accessories while the machine is in operation.
5. This product has a waterproof rating of IPX8, and can be submerged in water.
6. Do not attempt to remove the battery under any circumstances. If the product shell is broken, stop using it and do not charge it.
7. Please keep away from heat, oil, or flammable and explosive substances when charging.
8. Use the provided USB charging cable to charge the device.
9. Only use an adapter with the appropriate security certification that matches this device model.
10. This product is equipped with a built-in battery that cannot be removed. Please do not replace the battery by yourself to avoid damaging the battery or the device. Once charging is complete, disconnect the charger from the device and remove it from the power socket. Continuous charging time should not exceed 12 hours.

Important Reminders:

For safety during transportation, the product you received may not be fully charged. Please ensure to fully charge the product before its first use. Before using the scrubber, be careful not to get splashing stains into your eyes or on your skin. When the battery is low, the red indicator light will flash. It is recommended to charge the product promptly. During charging, the red indicator light should be on. If there is no red light, please ensure that the adapter is plugged in correctly and press the power button again. After charging, securely close the silicone cover to prevent water from entering and causing a short circuit.

Please check whether there are any missing parts after receiving the product. Please make sure that the scrubber is properly before use. When cleaning the surface such as stainless steel, polished resin, artificial marble, wood, etc., minor scratches may occur. It is advisable to test it in a small area first and ensure no abnormalities before proceeding with cleaning.

Please note that brushes are consumable items and are not covered to the warranty. Please keep the power cord plug and hands dry to avoid the risk of electric shock. Do not attempt to disassemble, repair or modify internal parts by yourself. Please contact us if you have quality issues.

Always wear appropriate eye protection and rubber gloves when using the power scrubber with irritating substances. When changing accessories, please make sure the machine is turned off and keep hair, clothing, and body parts away from brush head to prevent entanglement.

1. PRODUCT INSTRUCTIONS

This product is a hand-held electric cleaning brush designed for cleaning glass tank and various household surfaces. The motor drives the brush head to rotate, effectively removing stains and dirt. It can also be used for cleaning fish tanks.





2. PRODUCT FEATURES

1. Multiple brush heads are included for easy installation. Different brush heads are suitable for all kinds of cleaning tasks, such as glass tank cleaning and household use.
2. The main body of the brush is made of durable and eco-friendly plastic material, ensuring long-lasting performance. The telescopic tube is made of stainless steel.
3. Rechargeable and recyclable: low-voltage for enhanced safety.

3. PRODUCT PARAMETERS

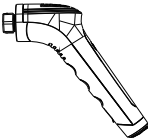
MODEL	HG086
Adapter parameters	Input AC100-240V/50-60Hz Output DC 5V
last work hour	Approx.90~120 min
Charge time	≤5 H
Mini handle length	Approx.22CM(8.7inch)
Approx. length	79CM(31inch) &103CM(40.5inch)
Built in battery	3.7V/2600mAh
Waterproof grad	IPX8

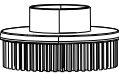
4. PRODUCT SPECIFICATIONS

Picture	Product name	Specification
	Telescopic handle	Extendable from 79 CM (31") to 103CM (40.5") in length
	Spin scrubber	Suitable for different brush heads for different functions
	Pointed brush	Cleaning glass corners, gaps and other areas
	Flat brush	Cleaning glass walls, tops, bottoms and other surfaces
	Arc brush	Cleaning curved surfaces such as rocks and aquarium decor

How to un-install the extension tube :
 please push the button first and twist untill the handle tube is out of the hole.

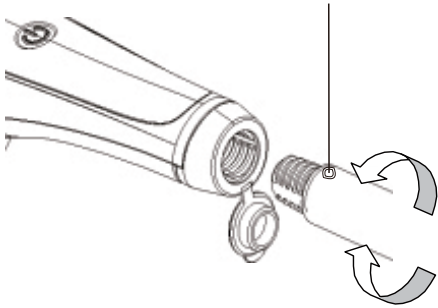

How to install the extension tube:
 Remove the silicone plug at the back of the electric cleaning brush. Screw the threaded end of the telescopic rod into the threaded hole of the brush, and twist until tightened.
 Note: Make sure that the telescopic rod and the brush are tightly connected before use.

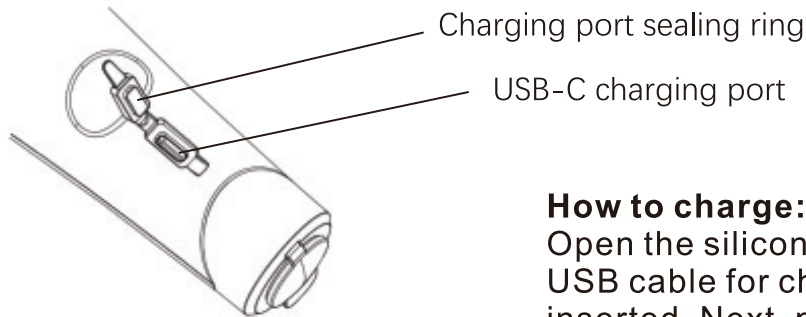



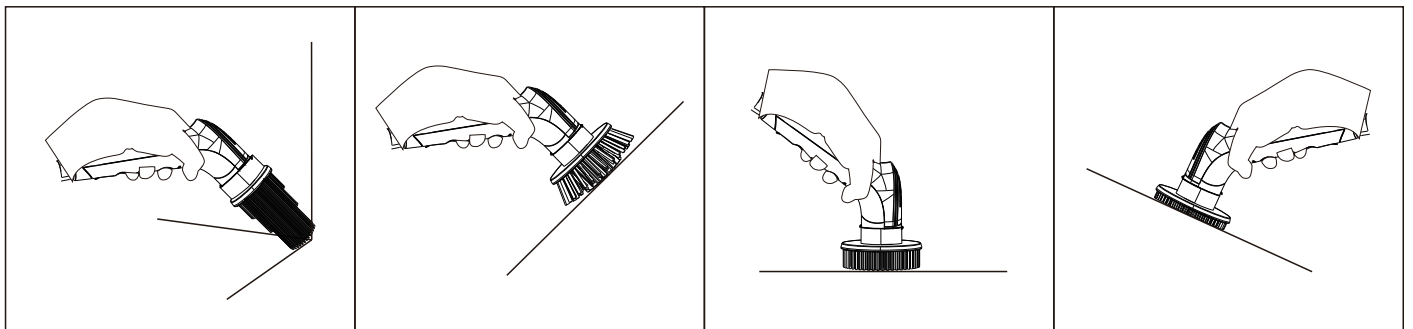
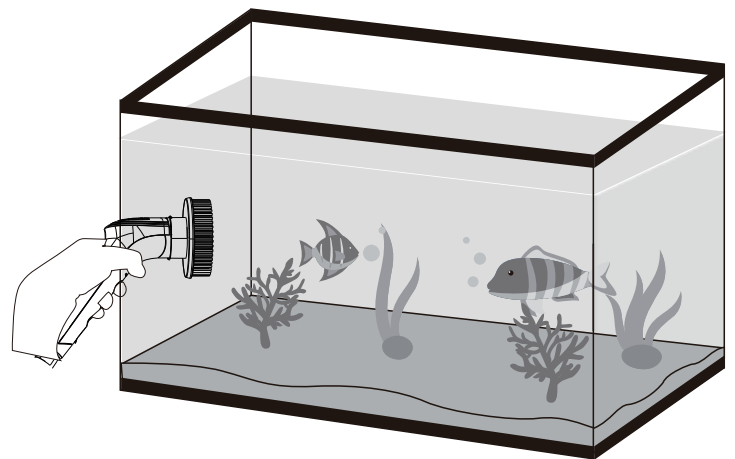
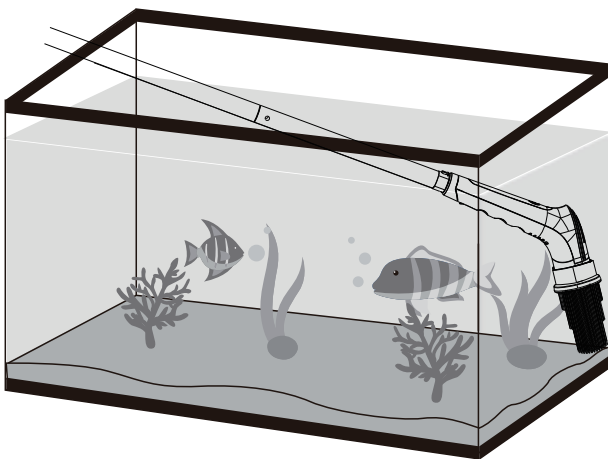

How to charge:
 Open the silicone charging cover and insert the USB cable for charging. Make sure it is fully inserted. Next, plug into an electrical outlet.

- The red indicator light will be displayed when the spin scrubber is being charged.
 - The green indicator light will be displayed when the spin scrubber is fully charged.
- Notice: Please remove the adapter promptly once the device is fully charged. Ensure that the silicone cover is closed to avoid water entering.

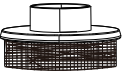
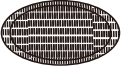
6. APPLICATION USE



Picture	Product name	Specification
	Large sponge brush	Cleaning glass walls, tops, bottoms and other surfaces
	Polishing cloth	Use for polishing glass surfaces after cleaning
	Scouring pad	Cleaning for glass and acrylic surface
	USB-C cable	Connector cable for charging
	Adapter	Power source connection

5. OPERATING MODE

1. Press ON/OFF button for the first time to activate the high gear of the machine. The red light will turn on;
2. Press ON/OFF button for the second time to activate the low gear. The green light will turn on;
3. Press ON/OFF button for the third time to shut down and turn off the light;
4. If the light is flashing, it indicates low battery power;
5. The charging process is indicated by a red light, which turns green when the battery is fully charged.

How to assemble the brush heads: Select the appropriate brush head according to the cleaning requirements.

Note: Before assembling any component of this product, make sure the unit is turned off and securely install the brush head.



How to remove the brush head:

Hold the connection part of the brush head and pull it out vertically.

7. SUGGESTION FOR STORAGE

Store the scrubber in a ventilated and shaded place. Avoid placing it in a wet or sun-exposed locations.

8. TROUBLESHOOTING

Why isn't the red indicator light while charging?

Check if the USB cable is properly inserted into the charging port. Verify if the charging socket is functioning properly or if there is a power outage. If the indicator light turns green after plugging in the adapter, it means the product is fully charged and ready for use.

- If none of the above reasons apply, please get in touch with our support team via email.

The charging indicator light doesn't turn green after charging for over 5 hours.

-Please check whether the socket and charging connection are secure before charging.

- If the product has been submerged in water during use, it may have damaged the internal circuit and could cause abnormal charging.

- If none of the above reasons apply, please get in touch with our support team via email.

Why does the brush head stop spinning during operation?

- If the red light flashes for 30s and then stops, it may be due to excessive pressure on the brush head, activating the automatic protection mode. Simply press the ON/OFF button once or twice to resume normal operation.

- If the red light keeps flashing without stopping, it indicates that the product has low battery and needs to be fully charged before use.

- If neither of the above conditions apply and the brush head stops spinning after less than 10 seconds or doesn't resume spinning after pressing the ON/OFF button twice, please contact our customer service via email.

Why does the charging indicator turn green (representing a full charge) but the brush head does not spin after being turned on?

-Please check whether the brush head connected to the extension rod and handle. Refer to the installation guide for proper connection methods.

-If it has been well-connected and the product has not been soaked completely in water before, but the scrubber does not spin after turning on or it stops spinning without pressing the brush head too hard, please get in touch with our support team via email.

Why does the brush head spin for less than 90 minutes or not work after pressing ON/OFF button twice when the battery is fully charged?

The working time of the brush head depends on the force applied during use. Excessive pressure on the brush head will result in a shorter working time (less than 80 minutes).

To extend the use time, avoid applying excessive pressure. Frequent excessive pressure may damage the brush head.

9. MAINTENANCE

1.If you do not use this product for an extended period, please ensure to charge it at least once a month.

2. The main engine of the product is waterproof (IPX8). After use, please clean the body and tubes with a dry cloth. Wipe off any water and allow it dry naturally.

3. Do not expose the surface of the product to strong corrosive liquids.

4. The DC charging port is waterproof. After charging, please securely put back the silicone cover.

5. Do not expose this product to temperature fire.

6. After using the cleaning accessories, allow them dry naturally.

10. WARNING

This appliance is not intended for use by persons (including children) with reduced physical, sensory or mental capabilities, or lack of experience and knowledge, unless they have been given supervision or instruction concerning use of the appliance by a person responsible for their safety. Children should be supervised to ensure that they do not play with the appliance.

11. FCC STATMENT

Operation is subject to the following two conditions:

This device may not cause harmful interference, and this device must accept any interference received, including interference that may cause undesired operation.

Note:

This equipment has been tested and found to comply with the limits for a Class B digital device, pursuant to Part 15 of the FCC Rules. These limits are designed to provide reasonable protection against harmful interference in a residential installation. This equipment generates, uses and can radiate radio frequency energy and, if not installed and used in accordance with the instructions, may cause harmful interference to radio communications. However, there is no guarantee that interference will not occur in a particular installation. If this equipment does cause harmful interference to radio or television reception, which can be determined by turning the equipment off and on, the user is encouraged to try to correct the interference by one or more of the following measures:

Reorient or relocate the receiving antenna. Increase the separation between the equipment and receiver. Connect the equipment into an outlet on a circuit different from that to which the receiver is connected.

Consult the dealer or an experienced radio/ TV technician for help.

11. PACKING LIST

- | | |
|---|-------------------|
| -1x Corner brush | -1x Spin scrubber |
| -1x Curved brush | -3x S/S tubes |
| -1x Flat brush | -1x USB cable |
| -1x Large sponge pad | -1x Adapter |
| -1x Polishing cloth | -1x Use manual |
| -1x Velcro brush holder with scouring pad | |

12. CONTACT INFORMATION

E-mail: service@hygger-online.com

Website: www.hygger-online.com