

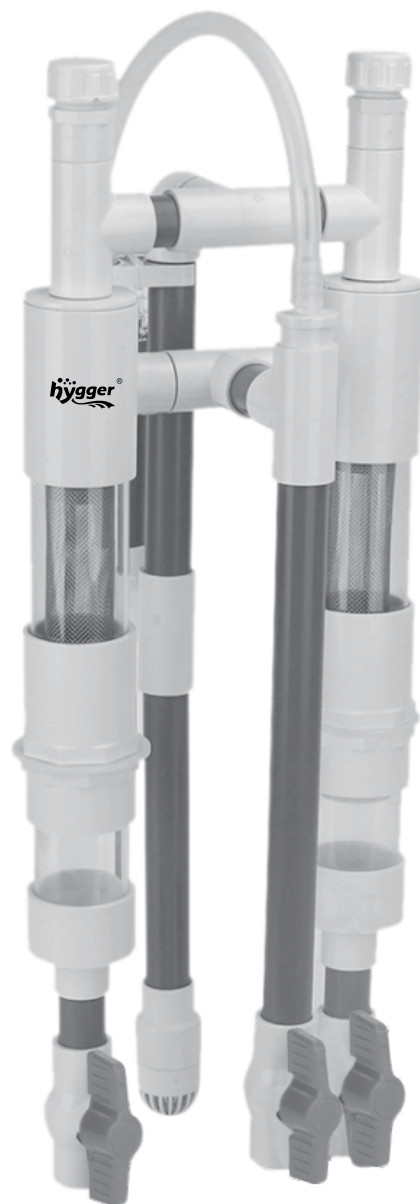

# HG141 hýgger fish waste collector USER MANUAL



**Red**



**Grey**

## PRODUCT DIAGRAM

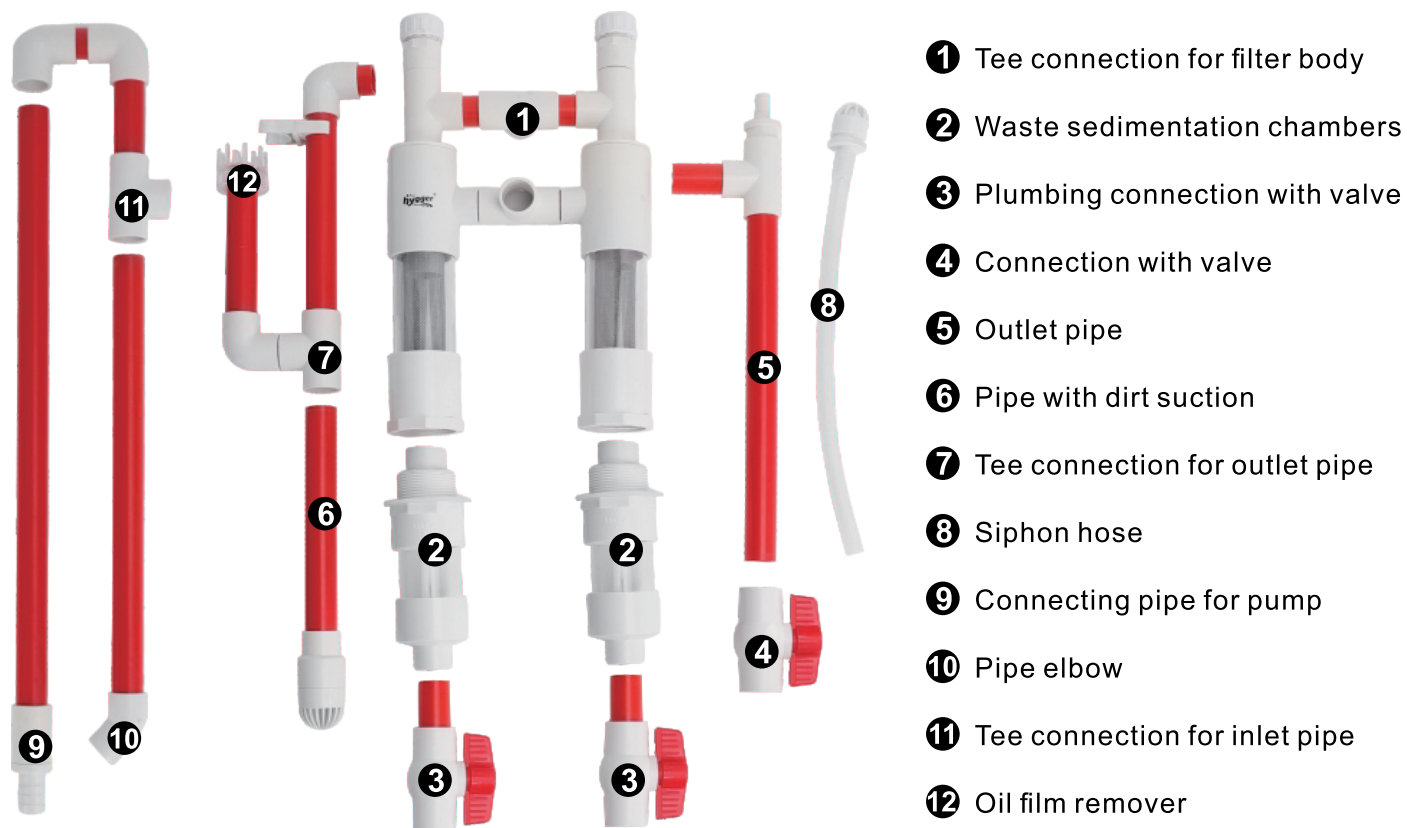

### 1. PRODUCT FEATURES

- No drilling is required and the sump tank is for ease of use. The fish waste collector must be equipped with a sump tank during operation.
- The fish waste collector is equipped with an oil film remover- removal of water surface oil film.
- Separation of fish waste for efficient disposal and discharge, reducing filter sponge cleaning time.
- A 304 stainless steel filter screen provides highly efficient filtration; most waste will remain on the screen. Additionally, the filter has an isolation layer that prevents the waste from migrating upwards. A loose pipe joint allows easy disassembly for cleaning the internal filter screen.
- Power outage, then water outage, automatic operation when restored.
- Separation of fish waste for efficient disposal and discharge, reducing filter sponge cleaning time.
- When the power is turned off, the water level in the tank drops. The siphon leaves the water surface, the air enters the siphon, and the water flow decreases. When the water level of the tank drops to parallel with the lowest edge of the T-pipe, the water flow stops.
- After switching on, the pump pumps water from the sump tank into the tank. The water level in the tank rises, and the siphon tube delivers the water downward. The water flow is initially low and gradually increases when the siphon is fully submerged.

## 2. PRODUCT SPECIFICATIONS

<b>Product size</b>	8.46"x9.84"x22.83"(21.5cmx25cmx58cm)	
<b>Inlet Pipe Size</b>	External diameter (0.79"/2CM)	Internal diameter (0.63"/1.6CM)
<b>Outlet Pipe Size</b>	External diameter (0.98"/2.5CM)	Internal diameter (0.83"/2.1CM)

## 3. ASSEMBLY INSTRUCTIONS

1. Before attaching the fish waste collector to the aquarium glass, ensure that the glass is aligned with the table's edge.
2. Each tank is different in size and use and requires different lengths of pipes, such as outlet pipes to the sump tank and T-pipe to the sump. Therefore, the user must manually measure and connect these pipe sections. The package includes pipes, pipe connections, tape, and a scissor for easy and flexible installation.

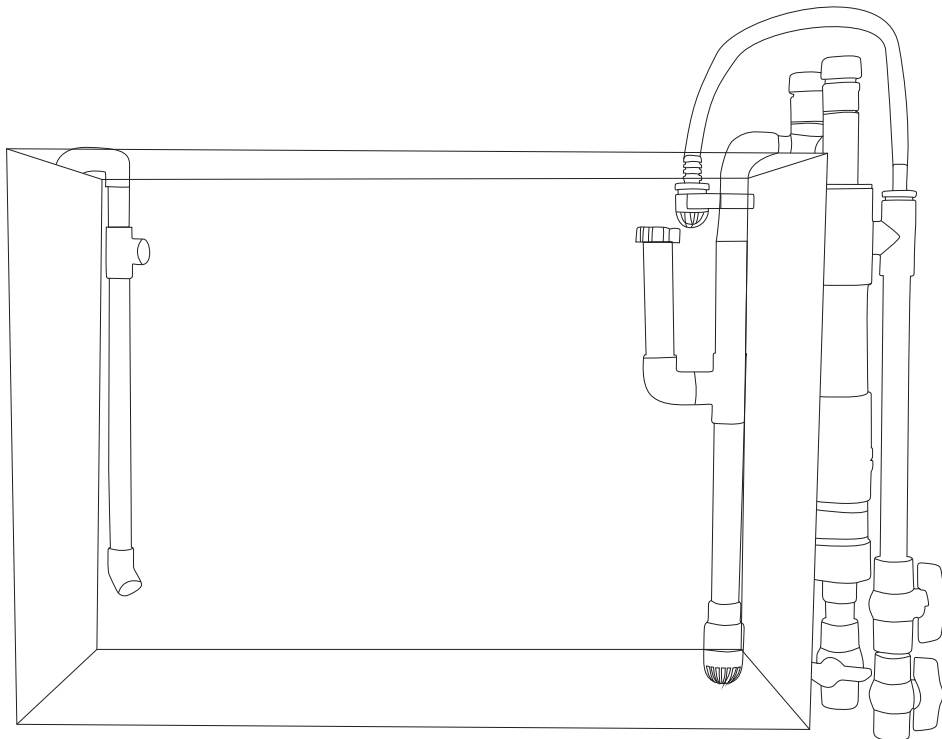

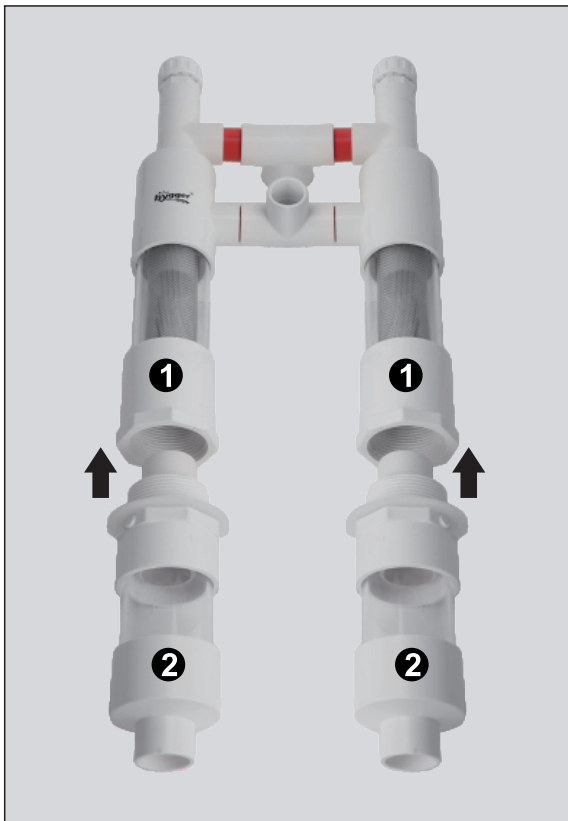

Step 1: Install the two waste sedimentation chambers ② on the filter body ①

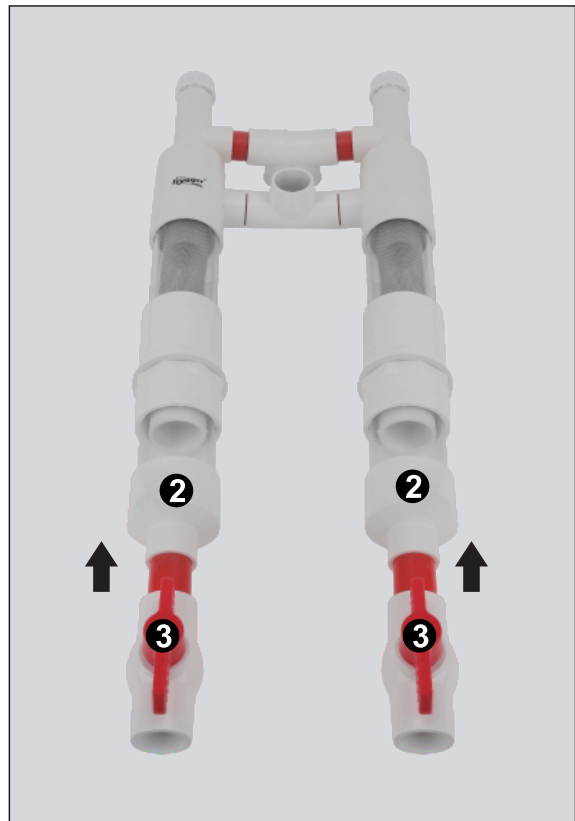

Step 2: Attach the two plumbing connections with valves ③ to the chambers ②



Step 3: Attach the connection with the valve ④ to the outlet pipe, and install the outlet pipe ⑤ to the lower tee connection of the filter body ①

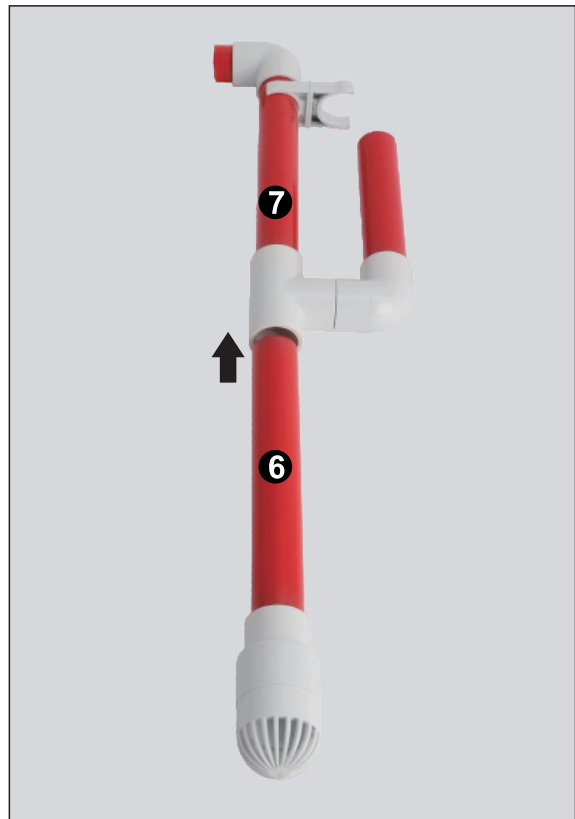

Step 4: Connect the pipe with the dirt suction ⑥ with the tee connection with oil film remover ⑦



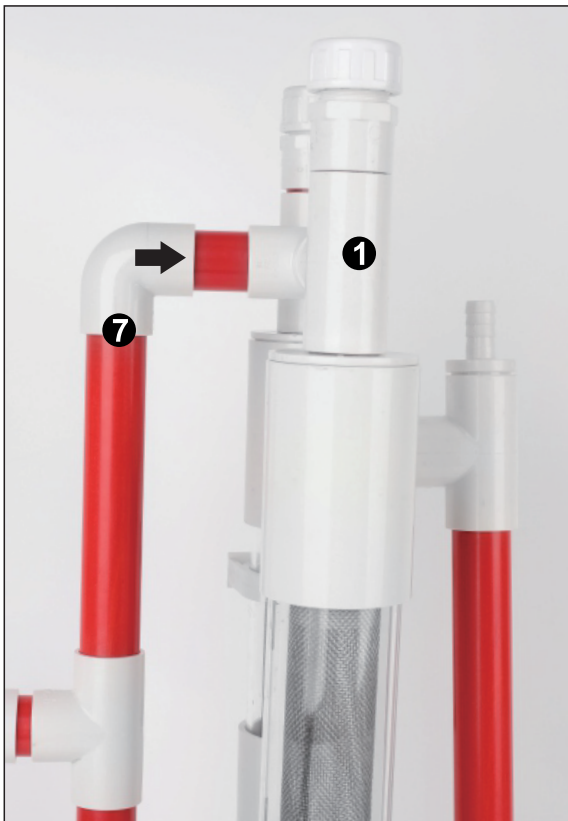

Step 5: Attach the plumbing connections ⑦ with the dirt suction to the upper tee connection of the filter body ①



Step 6: Attach the siphon hose ⑧ to the outlet pipe ⑤

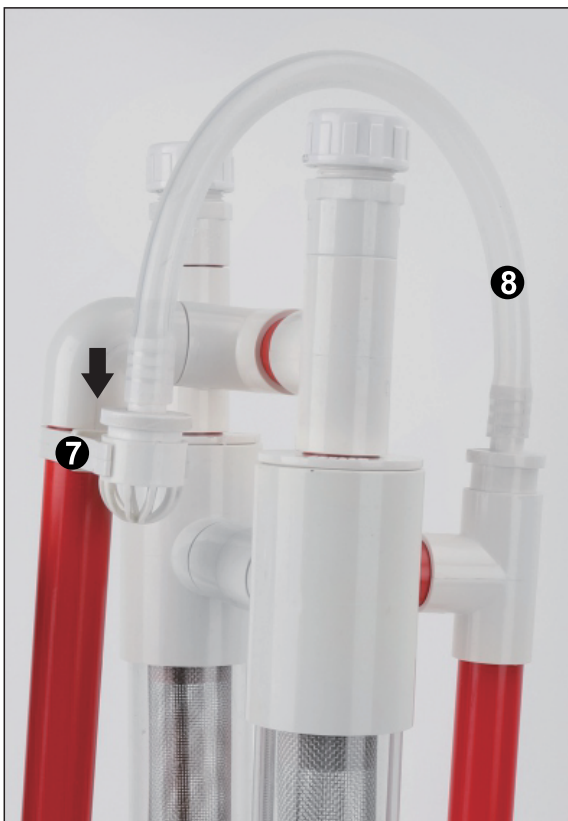

Step 7: Secure the end of the siphon hose ⑧ to the holder ⑦



Step 8: Install the oil film remover ⑫ on the pipe ⑫

## **4. INSTRUCTIONS**

1. Fill the tank and the sump tank until the water surface completely submerges the pump and the siphon comes into contact with the water surface.
2. Close the valve on the outlet pipe.
3. Open the cover of the water-filling nozzle and fill water into the filling nozzle (when using it for the first time, the water must be filled in manually; note that the valve must be closed when filling in the water).
4. Once the siphon tube is filled with water, cover the filling nozzle.
5. Place the siphon in the water, make sure the siphon touches the water surface, turn on the pump, and wait 5 seconds.
6. Open the valve.
7. After the appliance has operated generally for 1 to 2 minutes, adjust the position of the siphon in the tank so that the siphon is in contact with the water and 3 to 5 cm above the lowest end of the T-pipe.

Explanation: Operate for 1 to 2 minutes to push as much air as possible from the pipe.

Note: Ensure that the tank's water level does not drop too low below the lowest edge of the T-pipe and that the siphon does not leave the water surface when removing air from the pipe.

8. When the pump pumps water from the sump tank into the tank, the water level rises, the siphon tube delivers the water downward, and the water level in the tank begins to drop. As air enters the siphon, the water flow decreases, and the water level rises until the siphon contacts the water surface. The siphon tube delivers the water downward, and that cycle repeats. (Note: Slight fluctuations in water level are normal.)

9. If the water output is too high and the siphon is in constant contact with air, use valves to reduce the flow rate and noise during operation. (To ensure proper operation of the appliance, pay more attention when the appliance is operating).

## **5. ATTENTIONS**

1. If the water level in the tank is too high, use the valve on the outlet pipe to increase the amount of water output or reduce the pump's flow rate.
2. If the water level in the tank is too low, increase the pump's flow rate.
3. The above procedure can be adjusted as the water level in the tank changes.
4. There are two methods of preventing air from entering the siphon when the waste collector discharges the waste.

Method 1: Submerge the siphon 1-2 inches below the surface of the water while the waste collector is discharging the waste.

Method 2: Close the valve on the outlet pipe before discharging the waste. Wait 10 seconds after discharging until the water surface touches the siphon, then open the valve.

5. If air enters the siphon and the filter is not properly functioning, switch the power off immediately, close the valve on the outlet pipe and restart the unit.

6. Fill water into the filling nozzle, wait until the water reaches the siphon tube or the T-pipe, then cover the filling nozzle.

7. After energizing the pump, wait for the water level to submerge the siphon and open the valve on the outlet pipe to activate the siphon action.

8. The filter screen must be cleaned regularly to maintain its efficiency. (Note: Before cleaning the filter screen, drain all water from the pipe where the filter screen is located, and then unscrew the loose joint to remove the filter screen).

9. Critical areas of the pipes are reinforced with glue, and other connections must also be sealed with tape provided if they leak. Pipes usually have scratches or glue marks. Please feel relieved about the use!

## **6. PACKING LIST**

- 1x Filter body
- 2x Waste sedimentation chamber
- 1x Oil film remover
- 1x Siphon
- 1x Siphon hose
- 4x Pipe elbow (1"/2.5cm)
- 2x Pipe connection (1"/2.5cm)
- 2x Pipe connection (0.8"/2cm)
- 3x Valve
- 2x Pipe elbow (0.8"/2cm)
- 1x 45° Connecting elbow for pipe (0.8"/2cm)
- 1x 0.8"/2cm Connector for inlet pipe (Recommended for use with 1.6cm/0.6" hose)
- 1x Tee connection (0.8"/2cm)
- 1x Connecting pipe to oil film remover (1"/2.5cm)
- 1x Tee pipe connection for inlet pipe (1"/2.5cm)
- 1x Elbow connection for inlet pipe (1"/2.5cm)
- 2x Pipe holder (2"/5cm)
- 2x Double-sided holder (1"/2.5cm)
- 4x 15.8"/40cm Pipe (Dia:1"/2.5cm)
- 4x 15.8"/40cm Pipe (Dia: 0.8"/2cm)
- 1x Cleaning brush (Length: 15.8"/40cm)
- 1x Hopper
- 8x Zip tie
- 6x Suction cup
- 1x Scissor
- 1x Tape
- 1x User manual

## **7. CONTACT INFORMATION**

E-mail: [service@hygger-online.com](mailto:service@hygger-online.com)

Website: [www.hygger-online.com](http://www.hygger-online.com)